

Service-Anleitung
Service Manual
Instructions de Service

CR 900 RC







Technische Daten (typische Werte)	Specifications (typical values)	Caractéristiques techniques (valeurs types)	Dati tecnici (valori tipici)	
Tunerteil	Tuner section	Partie Tuner	Sezione sintonizzatore	Dual CR 900
Empfangsbereiche FM (UKW) AM (MW)	Reception wavebands FM (VHF) AM (MW)	Games de fréquences FM (OC) AM (OM)	Campi di ricezione FM (OUC) AM (onde medie)	87,5 – 108 MHz 522 – 1611 kHz
Empfindlichkeit (an 75 Ω) FM – Mono (26 dB) FM – Stereo (46 dB)	Sensitivity (at 75 Ω) FM – mono (26 dB) FM – stereo (46 dB)	Sensibilité (à 75 ohms) FM – Mono (26 dB) FM – Stéréo (46 dB)	Sensibilità (su 75 ohm) FM – mono (26 dB) FM – stereo (46 dB)	1,1 μV 30 μV
Trennschärfe FM stat./dyn.	FM selectivity stat./dyn.	Sélectivité FM stat./dyn.	Selettività FM stat./din.	80/70 dB
Geräuschspannungsabstand	Signal/noise ratio	Rapport signal/bruit	Rapporto segnale disturbo	70 dB
Verstärkerteil	Amplifier section	Partie amplificateur	Sezione amplificatore	
Ausgangsleistung Sinusleistung (8 Ω/4 Ω DIN 1 kHz) Musikleistung (8 Ω/4 Ω)	Power output RMS continuous power output (8 Ω/4 Ω DIN 1 kHz) music power (8 Ω/4 Ω)	Puissance de sortie Puissance sinus (8 ohms DIN 1 kHz) Puissance musique (8/4 ohms)	Potenza d'uscita capacità sinusoidale (8 ohm DIN 1 kHz) Potenza musicale (8/4 ohm)	2 × 60 W/2 × 75 W 2 × 80 W/2 × 100 W
Leistungsbandbreite	Frequency response	Bande de puissance	Banda di potenza	10–60000 Hz
Klirrfaktor bei 2/3 Leistung (1 kHz)	Harmonic distortion at 2/3 power (1 kHz)	Distorsion à 2/3 de puissance (1 kHz)	Distorsione armonica a 2/3 del rendimento (1 kHz)	< 0,01 %
Fremdspannungsabstand bezogen auf Nennleistung Phono-Eingänge Hochpegel-Eingänge (CD, VIDEO, TAPE)	Signal/noise ratio referred to rated power output Phono input High-level inputs (CD, VIDEO, TAPE)	Rapport non pondéré son/bruit par rapport à la puissance nominale Entrée Phono Entrées haut niveau (CD, VIDEO, TAPE)	Selettività riferita alla potenza nominale ingresso phono ingressi ad alte impedenze (CD, VIDEO, TAPE)	70 dB 90 dB
Übersprechdämpfung	Crosstalk attenuation	Diaphonie	Diafonia	80 dB
Eingänge CD, VIDEO, TAPE PHONO	Inputs CD, VIDEO, TAPE PHONO	Entrées CD, VIDEO, TAPE PHONO	Ingressi CD, VIDEO, TAPE PHONO	200 mV/47 kΩ 2,5 mV/47 kΩ
Ausgänge Druckklemmen für zwei Lautsprecherpaare 1-Koaxialbuchse 1/4 inch für Kopfhörer 1-Line-Ausgang an Tape	Outputs Clamping terminals for two speaker pairs 1 coaxial jack, 1/4 inch, for headphones 1-line output to tape	Sorties Bornes à pression pour deux paires de haut-parleurs 1 prise coaxiale 1/4" pour écouteurs 1 sortie Line sur Tape	Uscite morsetti di pressione per due coppie di diffusori 1 presa coassiale 1/4" per cuffia 1 uscita line su Tape	8–16 Ohm
Leistungsaufnahme (maximal)	Power input (maximum)	Consommation de courant (maximum)	Potenza assorbita (massimo)	300 Watt
Netzspannung Model Europa Model USA/Kanada	Mains voltage European model US/Canadian model	Voltage secteur Modèle Europe Modèle USA/Canada	Tensione di rete modello Europa modello Stati Uniti/Canada	230 V/50 Hz 115 V/60 Hz
Maße (Breite × Höhe × Tiefe)	Dimensions (width × height × depth)	Dimensions (largeur × hauteur × profondeur)	Dimensioni (larghezza × altezza × profondità)	440 × 122 × 280 mm

Abgleichanleitung CR 900 RC

Signalquelle	Einstellung Gerät	Einstellung Signalquelle	Meßgerät-Anschluß	Abgleichposition	Abgleich, Bemerkung
1) FM-Oszillator					
	87,5 MHz		DC-Voltmeter an TP 1 (R 402)	L 4	8,0 V DC \pm 0,2 V
	108 MHz			Kontrolle	ca. 1,6 V DC
2) FM-ZF Vorkreis					
FM-Meßsender an 75 Ohm Antenneneingang	Senderfreie Frequenz ca. 98 MHz	0–1 mV, Hub \pm 40 kHz, Mod. 1 kHz ca. 98 MHz auf Deckung	Klirrfaktormeßbrücke, Oszilloskop an NF-Ausgang	T1	NF-Maximum
				L 404	
	ca. 90 MHz	ca. 90 MHz auf Deckung		L 405	NF und Klirrfaktor Minimum
				Luftspulen L 1, L 2, L 3	Maximum
3) FM-ZF (Feinabgleich)					
Antenne an 75 Ohm Antenneneingang	Starken FM- Sender auf seiner Sollfrequenz empfangen		DC-Voltmeter an TP 3–TP 4 (über R 412)	L 405	DC-Max. und DC-Min. ermitteln
				L 405	Spannungsmittle einstellen
				L 404	0 V DC \pm 10 mV
				Abgleich wiederholen	
4) Pilotfrequenz 76 kHz, Kanaltrennung					
FM-Meßsender an 75 Ohm Antenneneingang	Senderfreie Frequenz ca. 98 MHz	ca. 98 MHz auf Deckung Hub \pm 40 kHz, Mod. 1 kHz 1–2 mV, ohne Pilotton	Frequenzzähler an TP 5 (Brücke 3 J 47)	VR 501	76 kHz \pm 50 Hz
	Monotaste: Aus	Mit 19 kHz Pilot	NF-Voltmeter, Oszilloskop an NF-Ausgang	VR 502	Maximale Kanaltrennung
5) Unterdrückung Pilotton (19 kHz)					
FM-Meßsender an 75 Ohm Antenneneingang	Senderfreie Frequenz ca. 98 MHz	ca. 98 MHz auf Deckung 1–2 mV 19 kHz Pilot ein	NF-Voltmeter, Oszilloskop an NF-Ausgang	LPF L	Minimum
				LPF R	
6) FM-Suchlaufschwelle					
FM-Meßsender an 75 Ohm Antenneneingang	Senderfreie Frequenz ca. 98 MHz	ca. 98 MHz auf Deckung Hub. \pm 40 kHz, Mod. 1 kHz, 10 μ V	Kontrolle am Display	VR 401	<input checked="" type="checkbox"/> <input checked="" type="checkbox"/> Anzeige muß aufleuchten
7) AM-Oszillator					
	MW 522 kHz		DC-Voltmeter an TP 1 (R 402)	L 402	1,6 V DC \pm 0,1 V
	MW 1611 kHz			TC 402	8,4 V DC \pm 0,4 V
				Abgleich wiederholen	
8) AM-ZF Vorkreis					
AM-Meßsender an AM-Antennen- eingang	999 kHz	10 μ V–1 mV, 1 kHz Mod. 30 % 999 kHz	NF-Voltmeter, Oszilloskop an NF-Ausgang	L 403	Maximum
	603 kHz	603 kHz		L 401	
	1404 kHz	1404 kHz		TC 401	
9) AM-Suchlaufschwelle					
AM-Meßsender an AM-Antennen- eingang	999 kHz	100 μ V, 1 kHz Mod. 30 % 999 kHz	Kontrolle am Display	VR 402	<input checked="" type="checkbox"/> <input checked="" type="checkbox"/> Anzeige muß aufleuchten

Tuning Instructions for CR 900 RC

Signal source	Equipment setting	Signal source setting	Connection of measuring instrument	Item to be tuned	Tuning, Remarks
1) FM oscillator					
	87.5 MHz		DC voltmeter to TP 1 (R 402)	L 4	8.0 V DC \pm 0.2 V
	108 MHz			Check	approx. 1.6 V DC
2) FM IF_i input circuit					
FM signal generator to 75 ohm antenna input	Frequency without transmitters approx. 98 MHz	0–1 mV, Shift \pm 40 kHz, Mod. 1 kHz Tune to approx. 98 MHz	Harmonic detector oscilloscope to AF output	T1	AF maximum
	approx. 90 MHz	Tune to approx. 90 MHz		L 404	AF and harmonic minimum
				L 405	
			aircoils L 1, L 2, L 3	Maximum	
3) FM IF (fine tuning)					
Antenna to 75 ohm antenna input	Receive strong FM transmitter at its nominal frequency		DC voltmeter to TP 3–TP 4 (over R 412)	L 405	Determine DC max. and DC min.
				L 405	Adjust power mean
				L 404	0 V DC \pm 10 mV
				Repeat tuning	
4) Pilotfrequencies 76 kHz, Channel separation					
FM Signal generator to 75 ohm antenna input	Frequency without transmitters approx. 98 MHz Mono key: OFF	Tune to approx. 98 MHz Shift \pm 40 kHz, Mod. 1 kHz 1–2 mV, without pilot	Frequency counter to TP 5 (bridge 3 J 47)	VR 501	76 kHz \pm 50 Hz
		with 19 kHz pilot	AF voltmeter, oscilloscope to AF output	VR 502	Maximum channel separation
5) Suppression of residual pilot frequencies (19 kHz)					
FM signal generator to 75 ohm antenna input	Frequency without transmitters approx. 98 MHz	Tune to approx. 98 MHz, 1–2 mV 19 kHz pilot ON	AF voltmeter, oscilloscope to AF output	LPF (left channel)	Minimum
				LPF (right channel)	
6) FM Search threshold					
FM signal generator to 75 ohm antenna input	Frequency without transmitters approx. 98 MHz	Tune to approx. 98 MHz Shift \pm 40 kHz, Mod. 1 kHz, 10 μ V	Check the display	VR 401	Signal   must light up
7) AM oscillator					
	AM 522 kHz		DC voltmeter to TP 1 (R 402)	L 402	1.6 V DC \pm 0.1 V
	AM 1611 kHz			TC 402	8.4 V DC \pm 0.4 V
				Repeat tuning	
8) AM IF_i input circuit					
AM signal generator to AM antenna input		10 μ V–1 mV, 1 kHz Mod. 30 %	AF voltmeter, oscilloscope to AF output		Maximum
	999 kHz	999 kHz		L 403	
	603 kHz	603 kHz		L 401	
	1404 kHz	1404 kHz		TC 401	
9) AM Search threshold					
AM signal generator to AM antenna input	999 kHz	100 μ V, 1 kHz Mod. 30 % 999 kHz	Check the display	VR 402	Signal   must light up

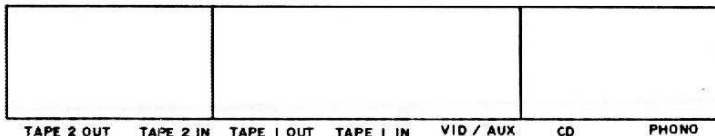

TAPE 2 OUT TAPE 2 IN TAPE 1 OUT TAPE 1 IN VID / AUX CD PHONO

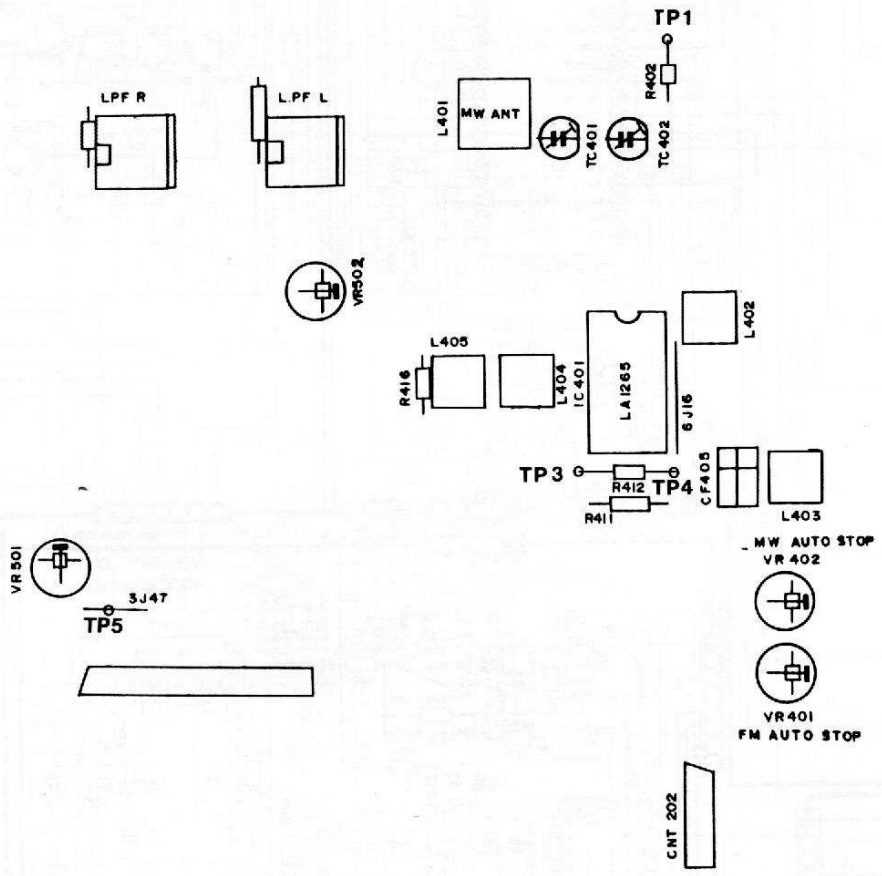
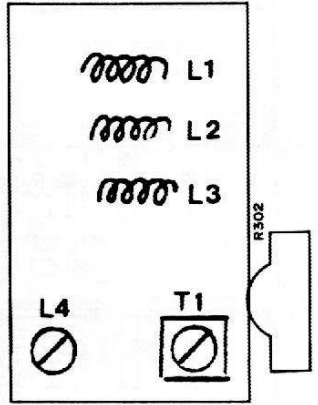

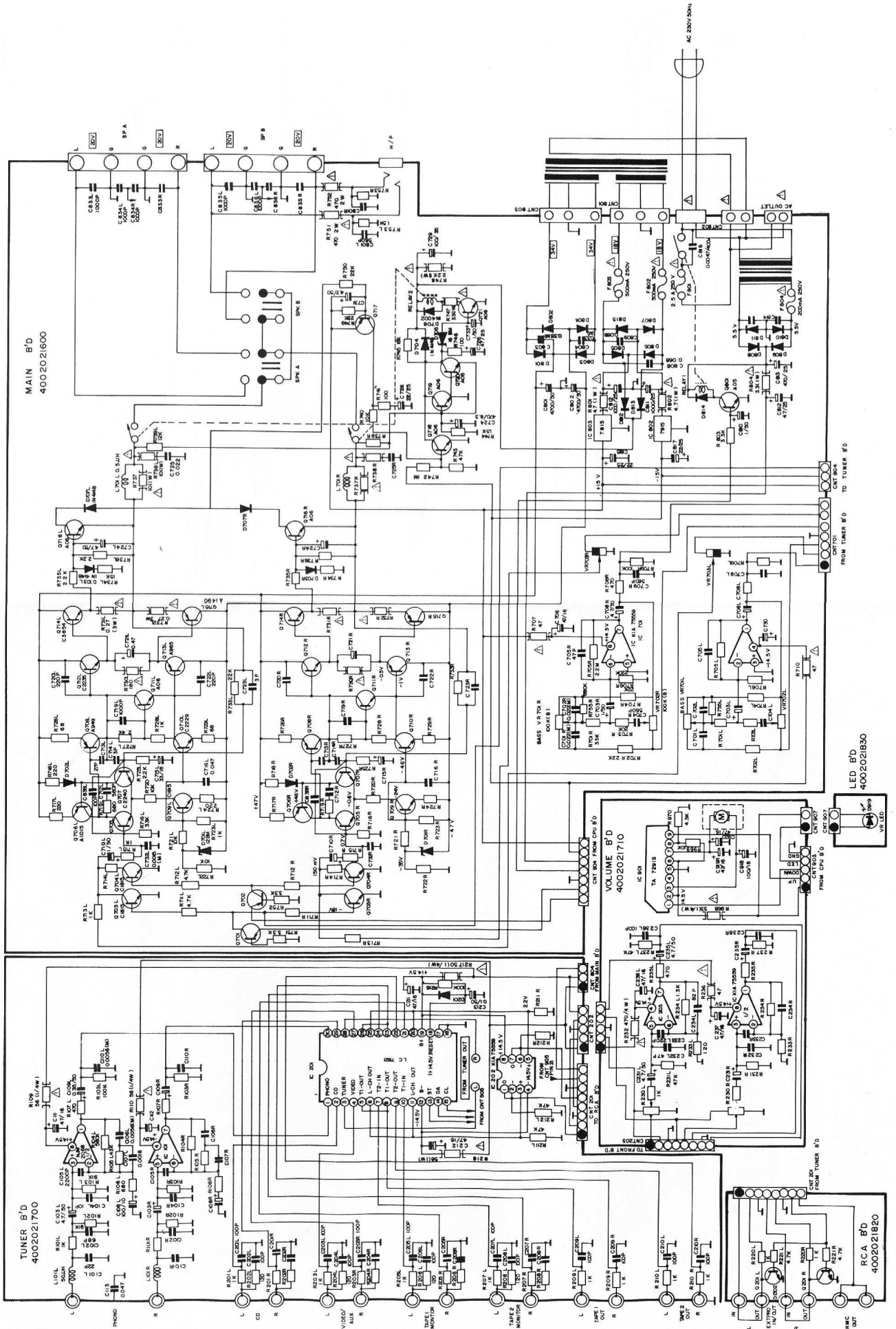

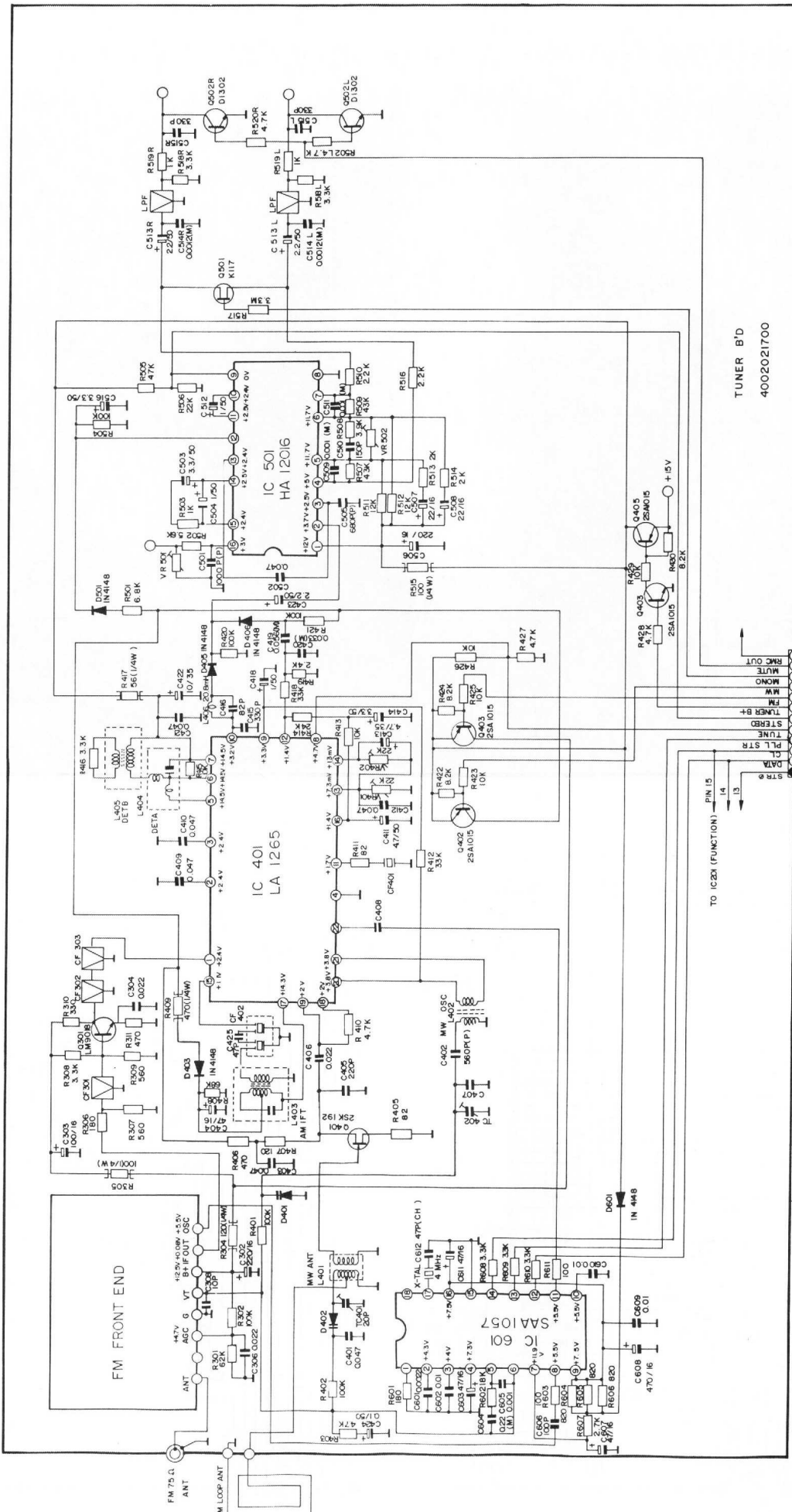

TUNER B'D
4002021700

FROM CPU B'D
ONT 900
RMC OUT
MUTE
MONO
FM
TUNER B+
STEREO
TUNE
PL STR
DATA
STR 0
PIN 15
I4
I3
TO IC2X (FUNCTION)

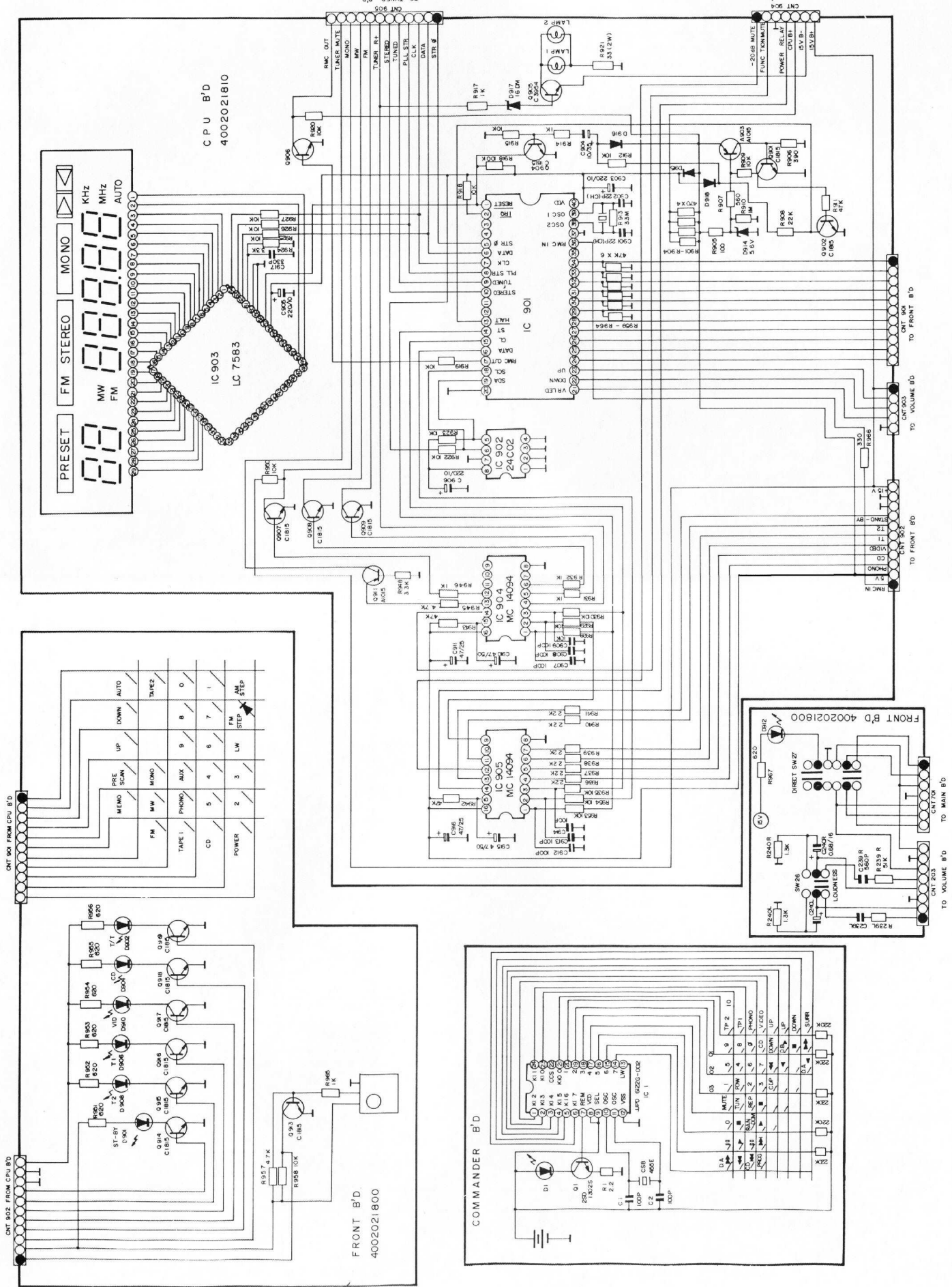

BLOCK DIAGRAM

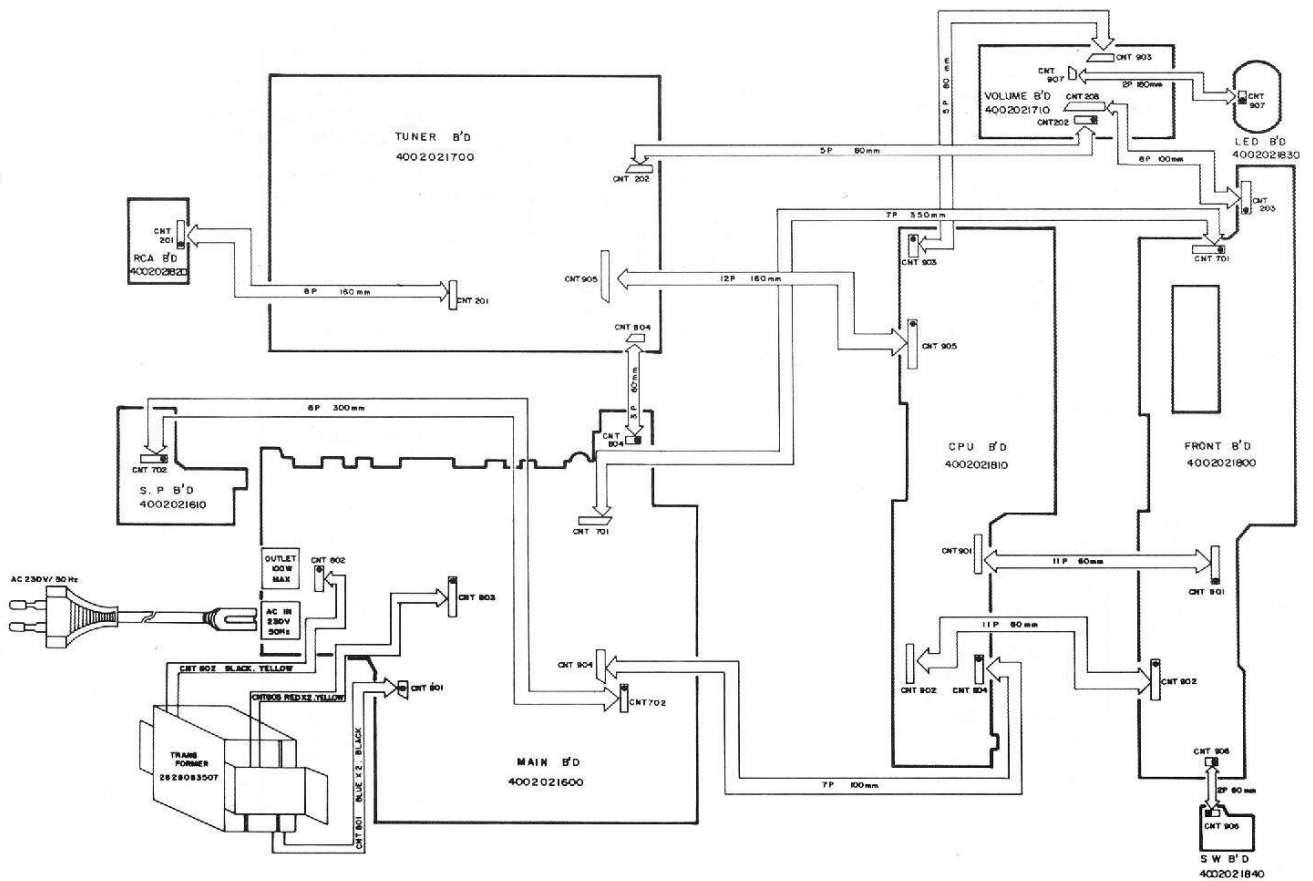
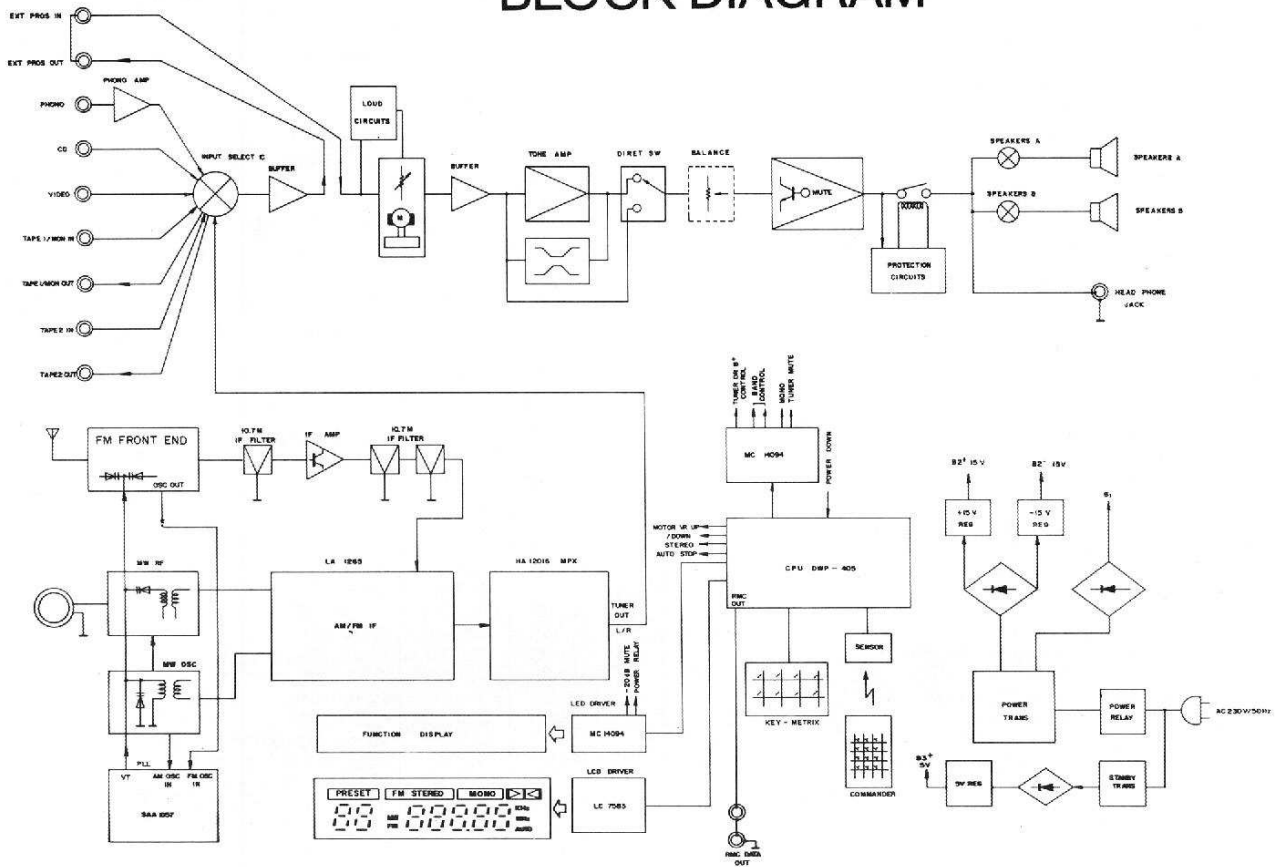

Ersatzteile · Replacement parts · Pièces détachées · CR 900

Pos.	Art.-Nr.	Bezeichnung
1	289 415	Frontblende CR 900
2	283 750	DUAL-Zeichen
3	289 244	Taste Power
4	289 294	Druckfeder
5	289 416	Drehknopf
6	289 417	Fenster
7	287 452	Sensorfenster
9	289 255	Knopf Volume
10	289 256	Leuchtstab Volume
11	289 418	Taste 2-fach
12	289 419	Taste 7-fach
13	289 420	Schalter
14	289 246	Taste
15	289 297	Tasten 10-fach
18	286 901	Schalter
19	289 420	Schalter
20	283 702	Schalter 3-fach
21	287 460	Schalter LOUD
22	289 257	Steller mit Motor
24	289 241	Fuß
25	289 705	Volume-LED-Platte
26	289 458	LED SLR 54 URC (Volume LED)
29	283 705	Kopfhörerbuchse
30	286 909	Trafo STAND BY
31	289 247	Schalter 2-fach
32	287 464	Steller 100 K x 2
33	287 463	Steller 100 K
40	289 359	AC-Buchse
41	289 267	Anschlußbuchse
42	289 269	Lautsprecherklemmen
43	289 437	Cinchbuchse
44	287 468	Cinchbuchse 6-fach
45	287 469	Cinchbuchse
46	287 470	Antennenbuchse
47	289 710	Anschlußbuchse 6-fach
48	289 711	Netztrafo
50	289 492	Gehäuseblech
51	286 908	Sensor KRM 34
52	287 462	Lampe
55	287 471	Stecker
56	279 596	Netzkabel Europa
57	289 305	Hilfsantenne
58	289 421	Druckfeder
59	289 312	AM-Antenne
60	282 135	Schraube 4 x 8
		Grundplatte
C 806	284 774	Elyt-Kond. 4700 UF/50 V
C 807	284 774	Elyt-Kond. 4700 UF/50 V
L 701	286 910	Spule 0,5 UH
D 701	282 063	Diode DZ 12 BM
D 702	223 906	Diode 1 N 4148
bis		
D 704	223 906	Diode 1 N 4148
D 705	287 473	Diode DZ 16
D 706	226 501	Diode 1 N 4002
D 707	223 906	Diode 1 N 4148
D 801	282 061	Diode 1 N 5402
bis		
D 804	282 061	Diode 1 N 5402
D 805	226 501	Diode 1 N 4002
bis		
D 814	226 501	Diode 1 N 4002
IC 701	283 707	IC KIA 75559 P
IC 802	289 491	IC MC 7915 CT
IC 803	288 679	IC GD 7815
RELAIS A	286 906	Relais 24 V
RELAIS B	286 913	Relais 12 V
Q 701	282 077	Transistor KTA 1015 Y
Q 702	282 077	Transistor KTA 1015 Y
Q 703	274 774	Transistor 2 SD 1302 T
Q 704	274 774	Transistor 2 SD 1302 T
Q 705	282 052	Transistor KTC 2240 BL
Q 706	282 077	Transistor KTA 1015 Y
Q 707	282 052	Transistor KTC 2240 BL
Q 708	282 054	Transistor KTA 949 Y
Q 709	282 076	Transistor KTC 1815 Y
Q 710	282 053	Transistor KTC 2229 Y
Q 712	282 094	Transistor KTC 2235 Y
Q 713	287 474	Transistor KTA 965
Q 714	287 475	Transistor KTC 3854
Q 715	287 476	Transistor KTA 1430

Pos.	Art.-Nr.	Bezeichnung
Q 716	286 904	Transistor MPS A 06
Q 717	282 077	Transistor KTA 1015 Y
Q 718	282 076	Transistor KTC 1815 Y
Q 719	286 904	Transistor MPS A 06
bis		
Q 721	286 904	Transistor MPS A 06
		Tuner-Platte
CF 301	284 782	Keramikfilter SFE 10,7
bis		
CF 301	284 782	Keramikfilter SFE 10,7
CF 401	284 784	Keramikfilter BFU 450
CF 402	287 479	Keramikfilter SFZ 450
L 101	286 910	Spule 50 µH
L 401	289 307	Spule AM
L 402	287 482	Spule MW OSC
L 403	289 422	Spule MW
L 404	282 183	Spule
L 405	282 184	Spule
L 406	282 321	Spule
D 201	223 906	Diode 1 N 4148
D 401	287 484	Diode KV 1235
D 402	287 484	Diode KV 1235
D 403	223 906	Diode 1 N 4148
D 405	223 906	Diode 1 N 4148
bis		
D 601	223 906	Diode 1 N 4148
	287 485	FM-Teil
IC 101	282 074	IC NJM 2068 DD
IC 201	286 912	IC LC 7821
IC 202	283 707	IC KIA 75559 P
IC 401	287 486	IC LA 1266
IC 501	284 541	IC HA 12016
IC 601	274 730	IC SAA 1057
Q 301	282 172	Transistor LM 9018 F
Q 401	282 178	Transistor 2 SK 192 GR
Q 402	282 077	Transistor KTA 1015 Y
Q 403	282 076	Transistor KTC 1815 Y
Q 404	282 077	Transistor KTA 1015 Y
Q 405	282 077	Transistor KTA 1015 Y
Q 501	283 208	Transistor 2 SK 117 BL
Q 502	274 774	Transistor 2 SD 1302 T
		UP-Platte
D 910	283 552	Diode DZ 5,6
D 915	223 906	Diode 1 N 4148
D 916	223 906	Diode 1 N 4148
D 917	282 173	Diode DZ 15 B
D 918	223 906	Diode 1 N 4148
IC 901	289 425	IC CPU DWP 405
IC 902	284 789	IC 24 CO 2
IC 903	283 717	IC LC 7583
IC 904	276 039	IC MC 14094 BCP C-MOS
IC 905	276 039	IC MC 14094 BCP C-MOS
LCD	289 423	Display
Q 901	282 076	Transistor KTC 1815 Y
Q 902	282 076	Transistor KTC 1815 Y
Q 903	282 077	Transistor KTA 1015 Y
Q 904	282 076	Transistor KTC 1815 Y
Q 905	282 094	Transistor KTC 2235 Y
Q 906	282 076	Transistor KTC 1815 Y
bis		
Q 909	282 076	Transistor KTC 1815 Y
Q 911	282 077	Transistor KTA 1015 Y
Q 912	282 076	Transistor KTC 1815 Y
bis		
Q 919	282 076	Transistor KTC 1815 Y
		LED-Platte
D 901	282 084	LED SLV 56 URC
D 906	275 455	LED SLR 54 GC
bis		
D 908	275 455	LED SLR 54 GC
D 910	275 455	LED SLR 54 GC
bis		
D 912	275 455	LED SLR 54 GC
RMC	289 424	IR-Sensor
Q 914	282 076	Transistor KTC 1815 Y
bis		
Q 920	282 076	Transistor KTC 1815 Y
		VOLUME-Platte
IC 203	288 707	IC KIA 75559 P
IC 901	267 489	IC TA 7291 S
Q 201	284 787	Transistor KTD 1302

Änderungen vorbehalten! Subject to change! Sous réserve de modification!

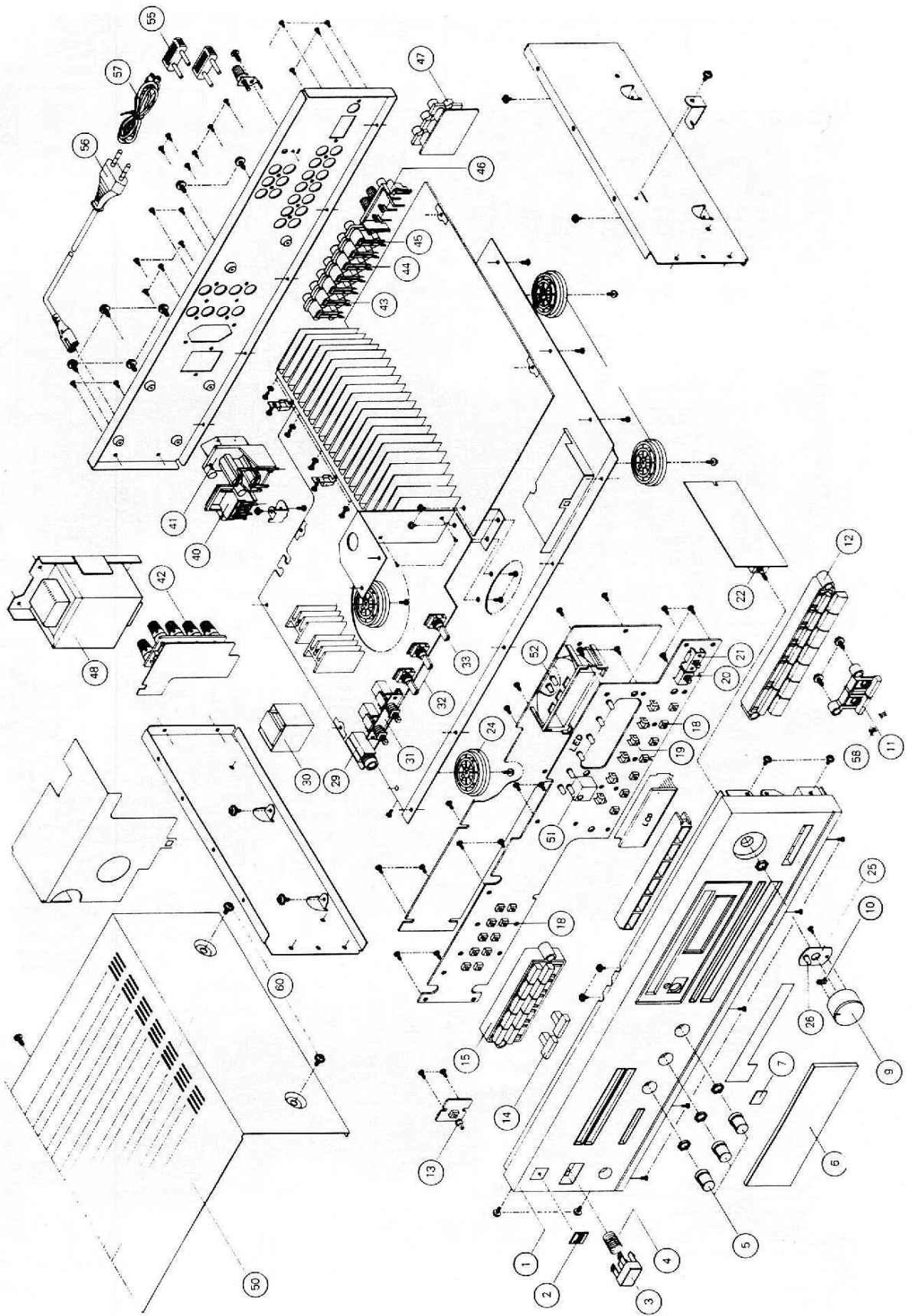

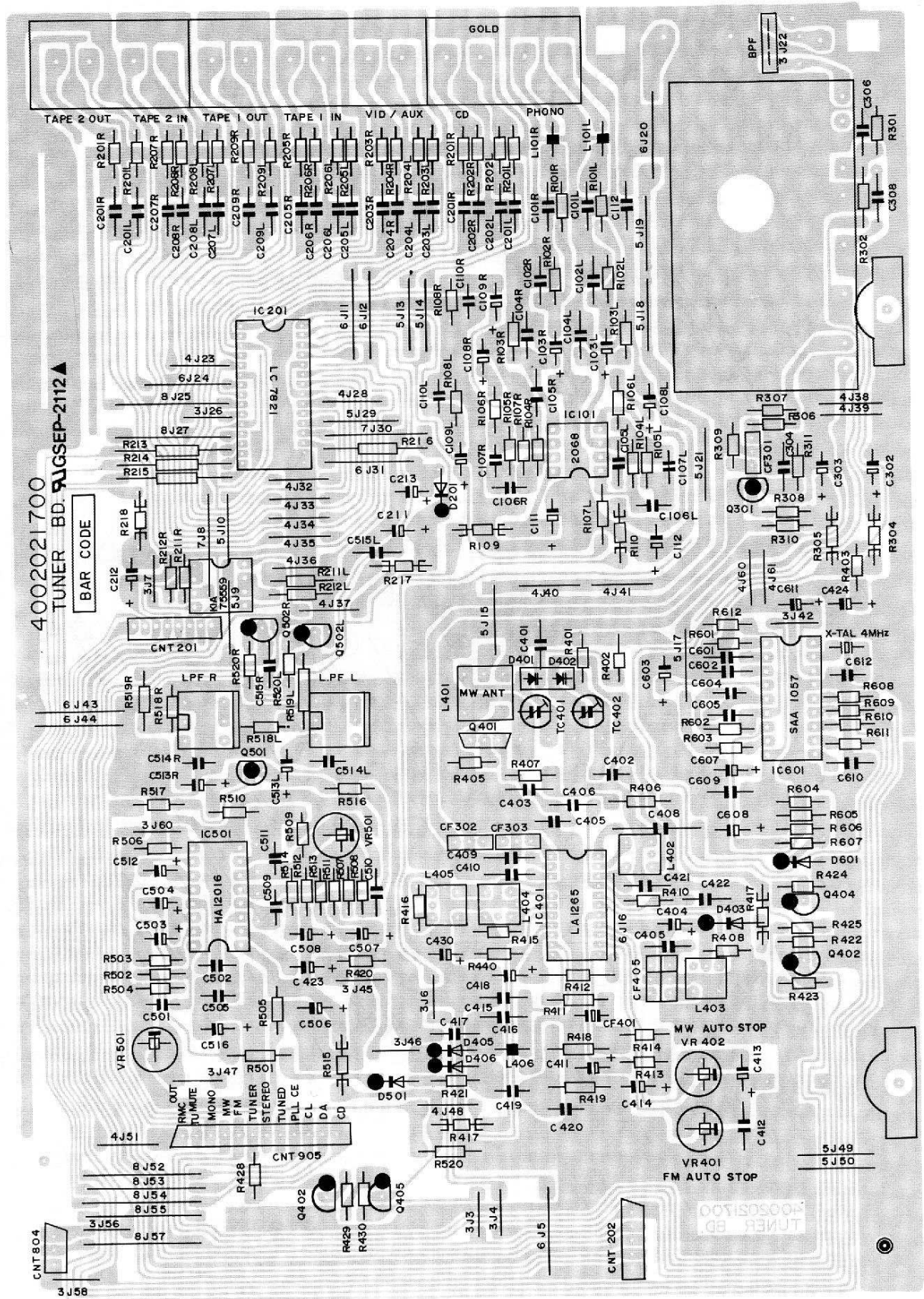

4002021700
TUNER BD. 9JGSEP-2112

CNT 804
3J58

4002021700
TUNER BD.

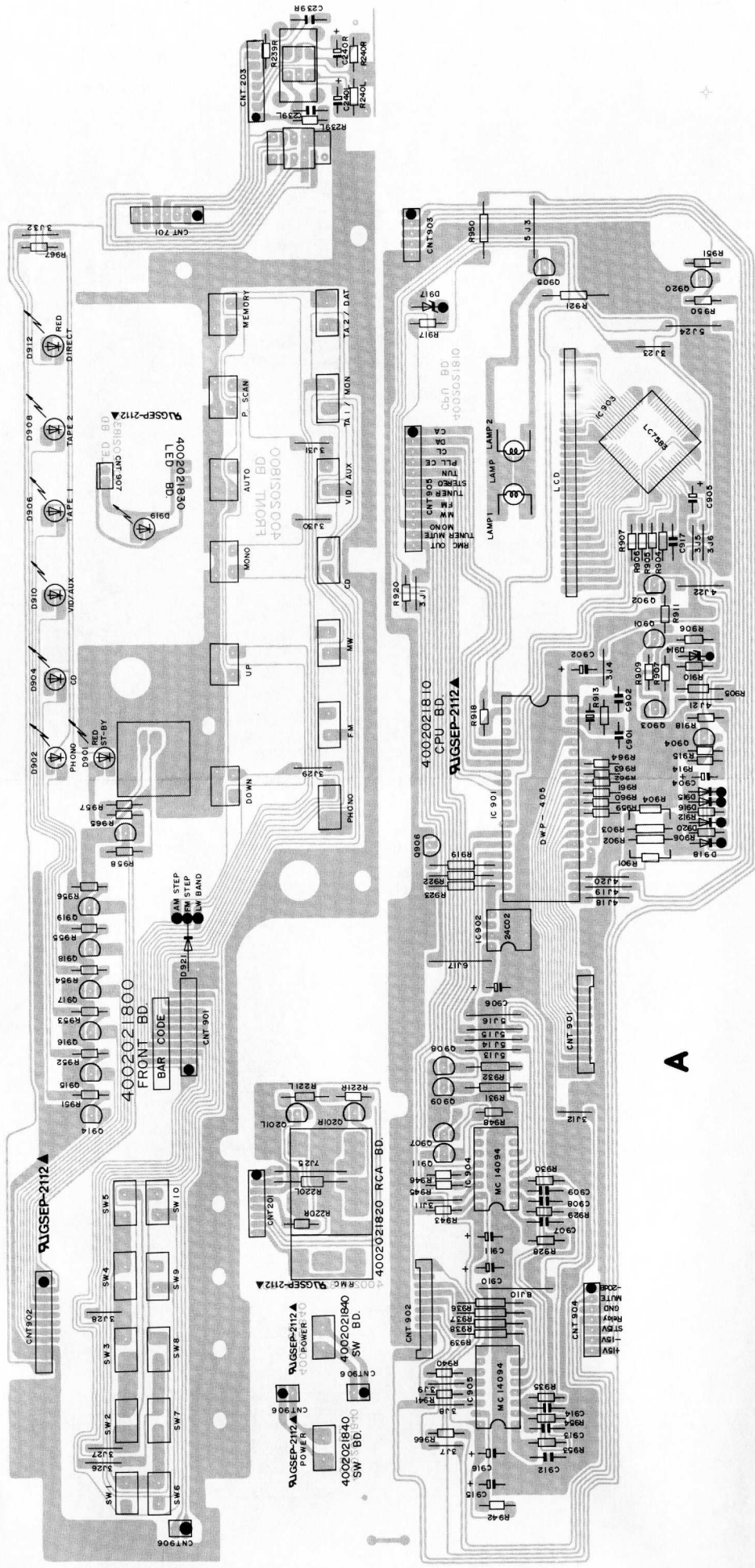

A

